

GLENDINNING

HoseMasterTM

Water Hose Retrieval & Storage System

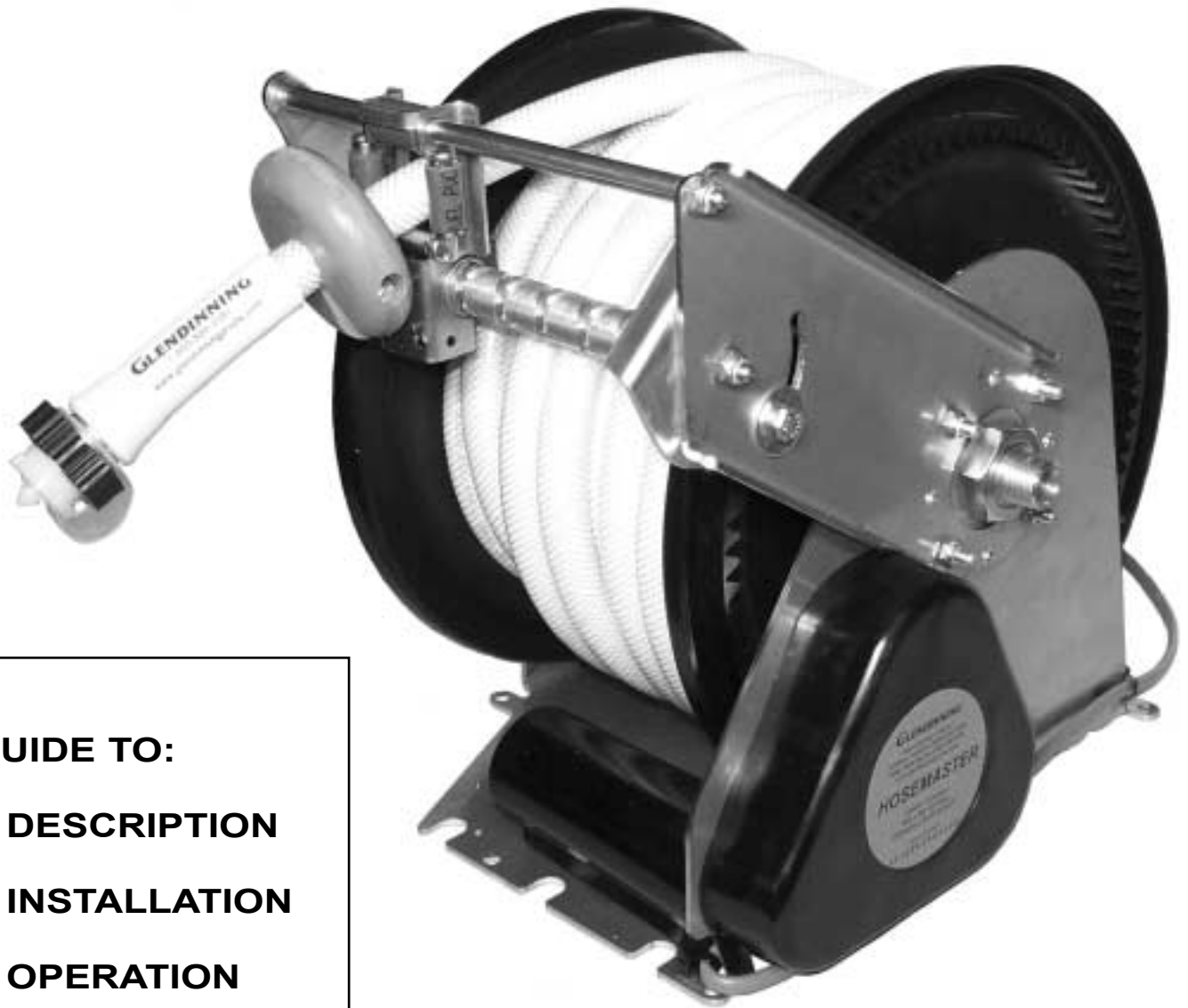

GUIDE TO:

- DESCRIPTION
- INSTALLATION
- OPERATION



740 Century Circle
Conway, SC 29526

Phone: (843) 399-6146
Fax: (843) 399-5005
www.glendinningprods.com

TABLE OF CONTENTS

THANK YOU...	PAGE 1
INTRODUCTION	PAGE 1
GETTING TO KNOW YOUR HOSEMASTER	PAGE 2
BEFORE INSTALLING THE HOSEMASTER	PAGE 3
Location for the HoseMaster	PAGE 3
Water Hose Exit	PAGE 3
Connection of Water	PAGE 3
INSTALLING THE HOSEMASTER	PAGE 4
WIRING INSTRUCTIONS	PAGE 4
OPERATION OF HOSEMASTER	PAGE 4
MAINTENANCE	PAGE 5
TROUBLE SHOOTING GUIDE	PAGE 5
APPENDIX	
Dimensions Diagram	PAGE 6
Wiring Diagram	PAGE 7
HoseMaster Accessories	PAGE 9
Product Registration Card	PAGE 10

INTRODUCTION

Welcome to the Glendinning family of quality products. Your new *HoseMaster* carries the same assurance of quality that has stood behind every Glendinning product for over 30 years. Each *HoseMaster* is manufactured under the strictest standards because we are proud of our reputation for quality products and excellent service.

This manual is intended to provide you with the basic understanding of the *Glendinning HoseMaster* and to familiarize you with the unit's installation and operation. The *HoseMaster's* installation is straight forward and easy. Using common sense about safety and a sound mechanical approach during the installation, the *HoseMaster* will provide many years of trouble-free service.

All *HoseMasters* have been designed for manual pay out and electrical retraction of your yacht's water hose. The *HoseMaster* will retrieve a maximum of 65 feet 5/8" water hose.

The *HoseMaster's* major components are; the main pulley / storage spool, mounting bracket, hose guide, motor, gear box, and water hose intake inlet.

THANK YOU...

for buying the Glendinning HoseMaster. At Glendinning, we are committed to providing you, our customer, with a product that will yield trouble-free service. Care has been taken during each phase of the manufacturing process to guarantee a lifetime of quality and performance—after all, our name is on it!



Paul & John Glendinning



ATTENTION:

The standards established by the National Electric Code and the recommended practices and standards of the ABYC (American Boat and Yacht Council, Inc.) should be followed when installing and operating this product.

Your safety is of the utmost importance! If you are unfamiliar with these practices, it is **STRONGLY RECOMMENDED** that you seek the help of a qualified electrician prior to installation.

Glendinning will not be liable for any loss, damage, incidental or consequential damages of any kind, arising in connection with the use or reliance upon this manual.

GETTING TO KNOW YOUR HOSEMASTER

OVERVIEW

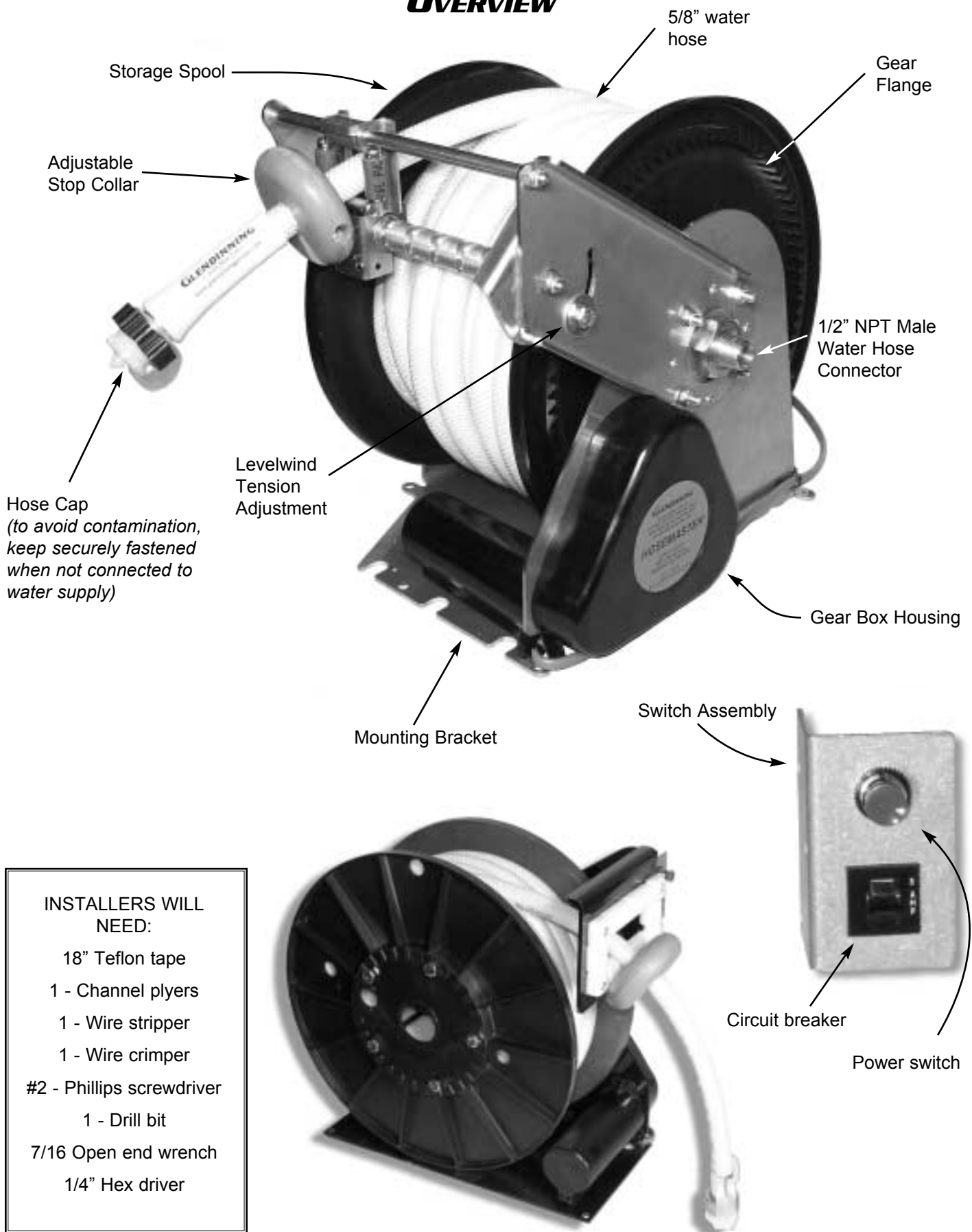

INSTALLERS WILL NEED:

- 18" Teflon tape
- 1 - Channel plyers
- 1 - Wire stripper
- 1 - Wire crimper
- #2 - Phillips screwdriver
- 1 - Drill bit
- 7/16 Open end wrench
- 1/4" Hex driver



BEFORE INSTALLING THE HOSEMASTER

BEFORE installing your *HoseMaster*, consider the following three points:

1 LOCATION FOR THE HOSEMASTER :

The first step in determining where to install your *HoseMaster* should be finding a suitable space where the *HoseMaster* will fit. The *HoseMaster* has been designed to fit in the most space-challenged areas of your yacht. The photo at right shows one possible installation. The typical size requirement for the *HoseMaster* is 14.00" deep x 13.00" high x 12.00" wide. Perhaps the easiest location for the *HoseMaster* to be installed is in a storage bay that is near the boat's water supply. The *HoseMaster* may also be located away from the water supply area by using a length of water hose routed from the water supply line to the *HoseMaster* (included in optional installation kit).

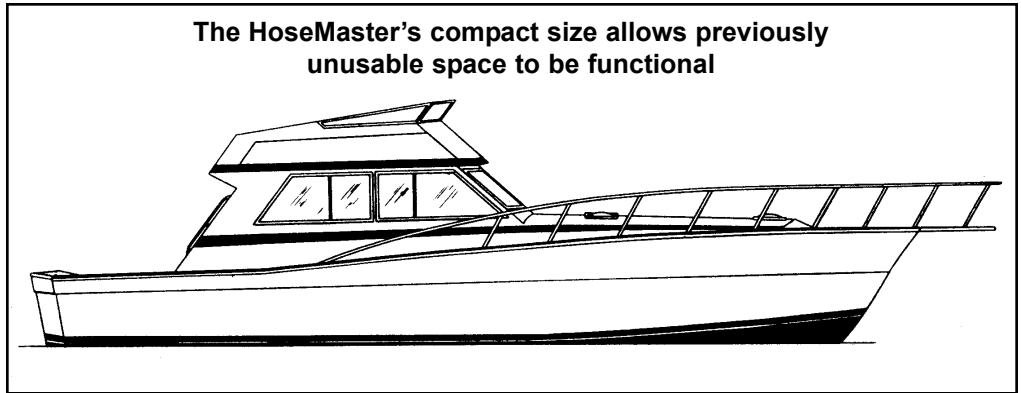

2 WATER HOSE EXIT :

The second step is determining where the water hose will exit the exterior of your boat. In some cases it may be preferable for the water hose to exit the aft through a hawse pipe, while in other applications it may be necessary to exit the side. One option also available would be to have the water hose installed in a storage compartment on the aft deck (see photo at left). In either case, a route must be identified that the hose will take from where it is stored to the outside of your boat.

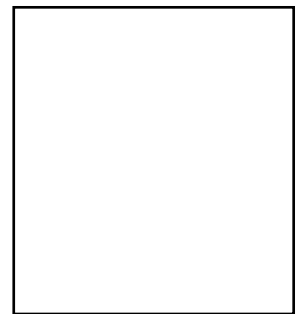
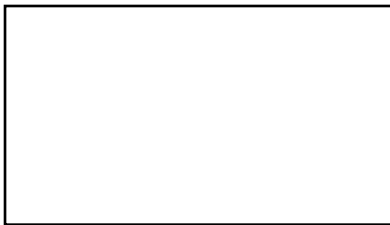

Aft Exit

3 CONNECTION TO THE BOAT'S WATER SYSTEM :

Connecting the *HoseMaster* to the boat's water system is very simple. In retrofits, simply route the existing hose line from the ship's water system inlet port to where you have installed the *HoseMaster*. Cut the hose at a suitable length and attach a 1/2" NPT female connector. Attach the female connector to the 1/2" NPT male water hose inlet, located in the center of the main pulley wheel of the *HoseMaster*. If you prefer to replace your existing hose with a new one, then route a length of approved 5/8" water hose from your ship's water system inlet port to the *HoseMaster* water outlet port and connect as described above (see drawing below).

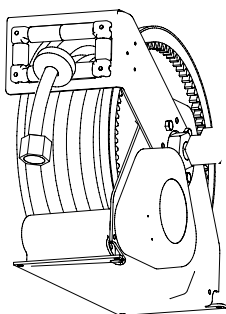

BOTTOM MOUNT CONFIGURATION

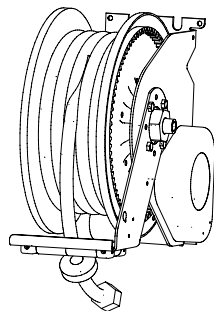

WALL MOUNT CONFIGURATION

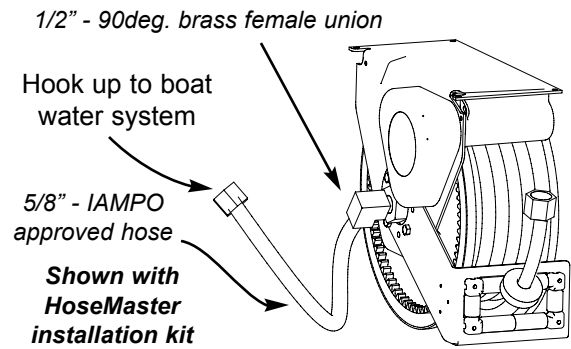

TOPMOUNT CONFIGURATION

B INSTALLING THE HOSEMASTER

The *HoseMaster* system must be mounted in a location that is protected from the elements and that does not contain combustible fuels. Generally, an existing space in the engine room near the water storage tank is an acceptable location.

Mount HoseMaster

MOUNTING THE HOSEMASTER

In general, the *HoseMaster* system will be mounted to either the floor or the roof of the compartment where it will be located.

Determine where the *HoseMaster* will be mounted. It is very important to allow clearance for the *HoseMaster* storage spool to operate freely without obstruction or interference, and for the connection of the water hose from the ship's water supply.

Install the mounting bracket by using six (6) #10 fasteners (*HINT: Unspooling the water hose before mounting the HoseMaster can aid installation in tight spaces.*)

CONNECTING THE HOSEMASTER TO YOUR BOAT'S WATER SYSTEM

As mentioned in section 3 of the Installation Guide (opposite page), the connection of the *HoseMaster* to your ship's water system is fairly straightforward and simple.

To retrofit the *HoseMaster* to your coach simply route the existing hose line from the boat water system inlet port to where you have installed the *HoseMaster*.

Attach the female connector to the 1/2" NPT male water hose connector, located in the center of the main pulley wheel of the *HoseMaster*.

Cut the hose at a suitable length and attach a 1/2" NPT female connector.

If you prefer to replace your existing hose with a new one, then route a length of drinking water safe 5/8" water hose from the boat's water system inlet port to the *HoseMaster* water connector as described above (*see pg. 10 for Accessories.*)

MOUNTING THE HOSEMASTER POWER SWITCH

The *HoseMaster* power switch comes already assembled, and should be mounted near the hawse pipe where the hose will exit the boat's sidewall with (2) #8 fasteners (needed).

You are now ready to connect the *HoseMaster* to your boat's electrical system.

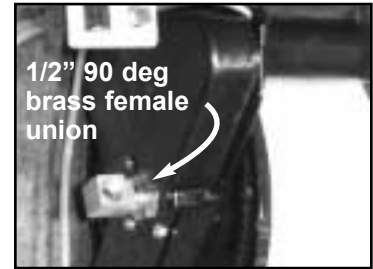

Connect to ship's
water system



Mount power switch

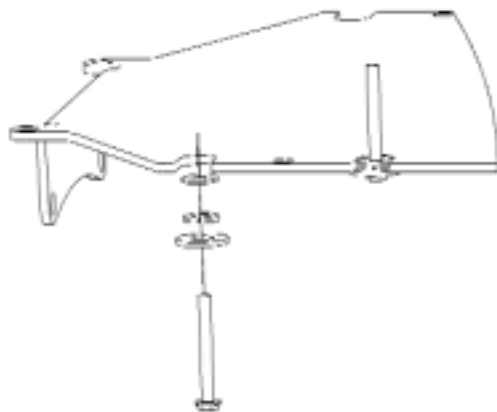

To aid in the installation of your *HoseMaster* a mounting template has been enclosed in this manual.

- 1) Tape template where installation is to occur, leaving appropriate clearance for hose connection and reel wheel. Mark mount holes.
- 2) Drill holes and install screw/fender washer, cut screw and SAE washer. Tighten screws until plate fits snug under fender washer. Position the cut washer to angle fender washer forward.
- 3) Install plumbing onto *HoseMaster*, and perform leak check.
- 4) Slide *HoseMaster* onto screws.
- 5) Install front mounting hardware.
- 6) Connect wires and mount the power switch.

C WIRING INSTRUCTIONS

The *HoseMaster* comes with (2) 14 gauge wires attached to the motor via the power switch assembly. These wires should be connected to the 12vdc power source. The white wire should be connected to the positive terminal and the black wire should be connected to the negative terminal. It is important to install a 10amp fuse close to the power source in-line with the white wire. This installation will prevent damage to your boat (*see wiring diagram page 7.*)

Make sure all connections are secure.

If you are NOT familiar with the standards and practices for DC electrical systems it is STRONGLY RECOMMENDED that you contact a qualified electrician.



OPERATING INSTRUCTIONS

Keep the female hose hookup clean at all times to avoid contamination. Keep the hose cap (pg. 2) installed whenever the hose is disconnected from a supply bib!

To operate the *HoseMaster*, follow these steps:

- **PULL OUT ONLY** the amount of hose required to reach the dockside water supply bib.
- **TURN ON** the dockside water supply to remove any standing water, then turn OFF.
- **REMOVE** the *HoseMaster*'s hose cap and inspect gasket.
- **SCREW THE FEMALE HOSE FITTING** onto the dockside water supply bib until leak-tight.
(use 51564 (optional accessory) at docks with high supply pressures to protect your vessel's system)
- **TURN ON** the dockside water supply. Ship is now being equipped with water from dockside supply.

When ready to get underway:

- **TURN OFF** dockside water supply and release hose pressure by disconnecting hose from supply.
- **INSPECT HOSE CAP** for contamination; clean if necessary and screw hose cap onto water hose.
- **PUSH AND HOLD** the *HoseMaster* power switch (red button). *HoseMaster* will electrically retrieve the water hose and store it on the self winding wheel.
- When hose has been retracted, **RELEASE** the push-button power switch to stop the unit (*continuing to push the power button may cause damage to the motor and will cause the circuit breaker switch to trip—reset before next use*).

REMEMBER:
Always disconnect AND fully retract your water hose BEFORE getting underway!



MAINTENANCE

The *HoseMaster* was designed for longevity of operation with very little maintenance required. When dealing with a drinking water safe device, it is extremely important to keep exposed parts that come into contact with your potable water free of debris or contaminants. With each use of the *HoseMaster* always **REPLACE THE HOSE CAP** when the water hose is disconnected from a supply source.

CHECK TO MAKE SURE NOTHING IS RUBBING or binding on the storage spool.

CHECK ALL WIRING CONNECTIONS, at least once a year, to be sure they are secure and free of corrosion.

F TROUBLE SHOOTING GUIDE

COMPLAINT	PROBABLE CAUSE	RECOMMENDED ACTION
Non-functional (either no power or unit has power and does not respond)	<ul style="list-style-type: none"> ○ Tripped breaker ○ Blown fuse at power source ○ Power wire incorrectly connected to power source ○ Defective motor 	<ul style="list-style-type: none"> ○ Reset breaker ○ Check power source fuse and connections, reconnect or replace if necessary ○ With power switch on and voltage across motor wires — if no response, replace motor
Pays out hose only	<ul style="list-style-type: none"> ○ Power inputs reversed 	<ul style="list-style-type: none"> ○ Check polarity on DC input wires
<i>HoseMaster</i> stops retracting while button is being pushed	<ul style="list-style-type: none"> ○ Hose jammed during retraction causing breaker to trip 	<ul style="list-style-type: none"> ○ Reset breaker ○ Pay out hose and rewind

G HOSEMASTER DIMENSIONS

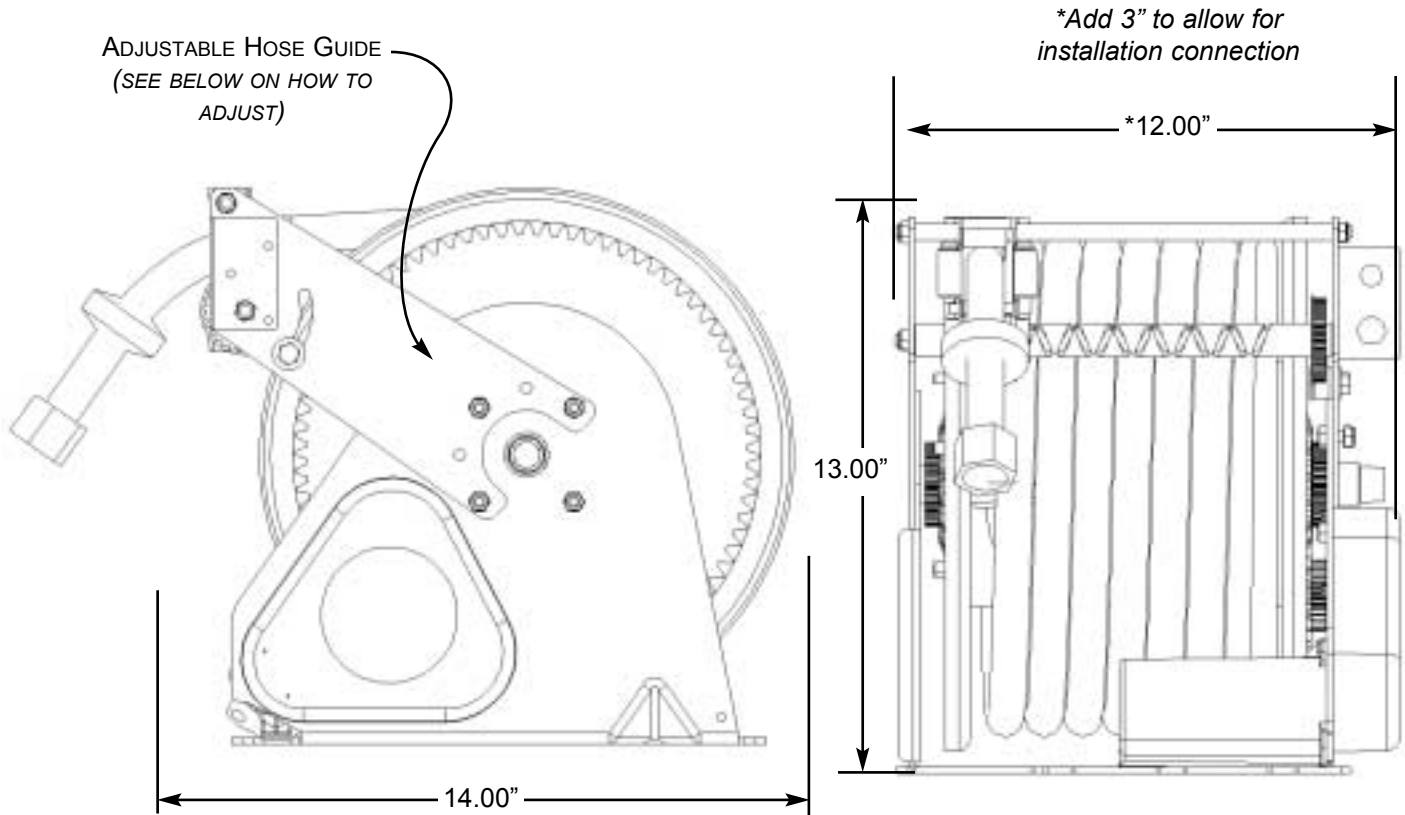

HOW TO ADJUST THE HOSE GUIDE

What you will need:

- 7/16" socket wrench
- 7/16" open-end wrench

*Cordless drill optional

Follow these steps:

- 1—Remove the (4) bracket nuts on the face of the hose guide. *Be careful not to remove the bolts.*
- 2—Remove the adjustable hose guide.
- 3—Reinstall hose guide arm by aligning bolts to holes when at desired position.
- 4—Carefully replace hose guide and attach the (4) bracket nuts (*step 1*). Tighten all nuts on hose guide.



Hose Guide adjusts to 5 positions yielding greater flexibility during installation

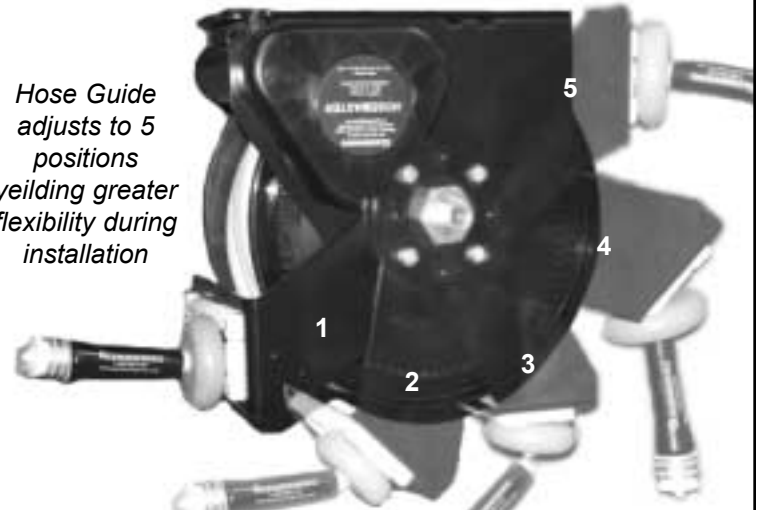



HOSEMASTER WIRING DIAGRAM

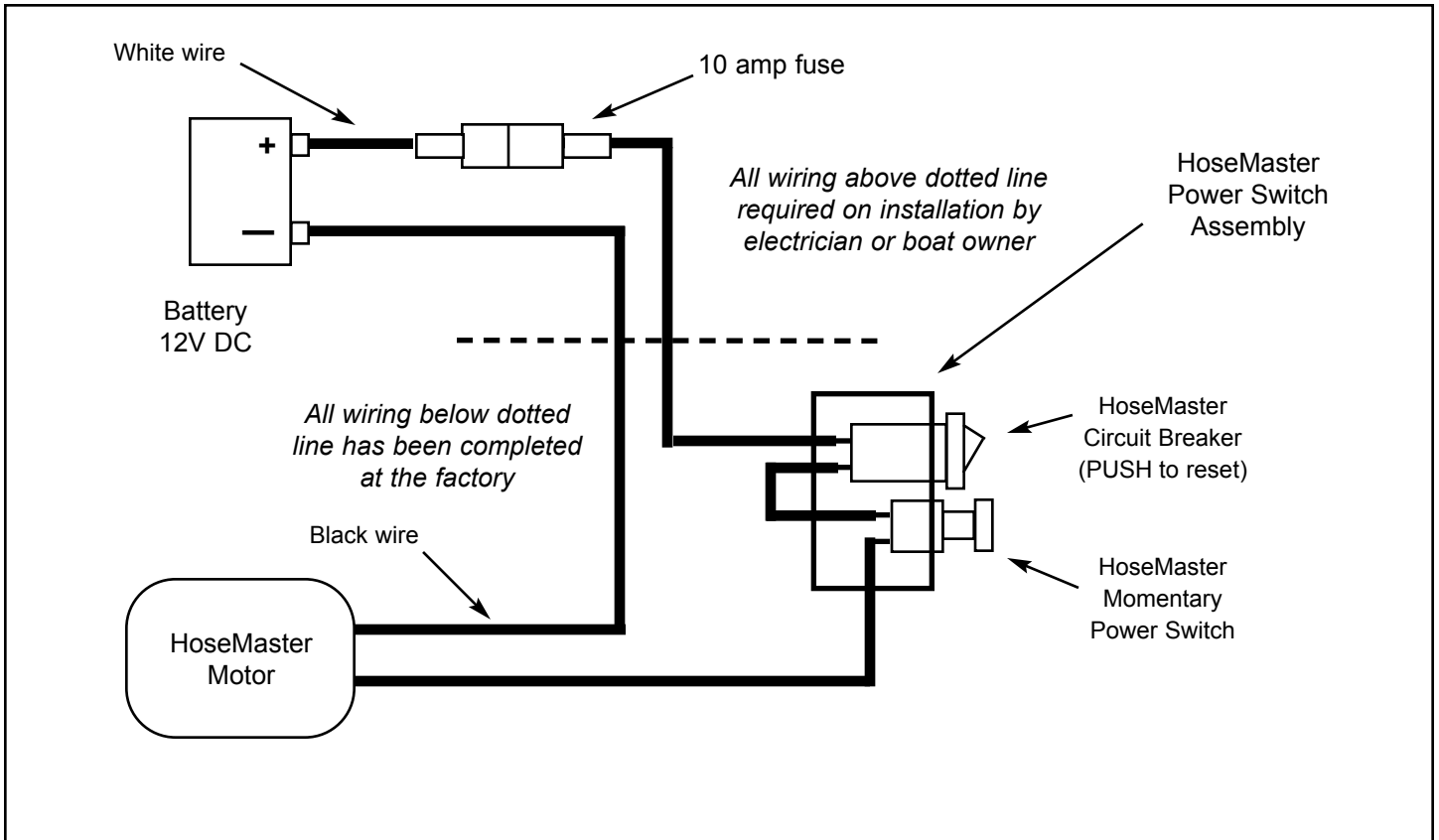

WARNING: If you are not sure on how to wire your HoseMaster DO NOT ATTEMPT TO CONNECT POWER TO THE UNIT, contact a qualified electrician.

The 2 wire connection to vehicle power is all that is required for installation of the Glendinning *HoseMaster*. All other wiring has been completed at the factory.

IMPORTANT: Install a 10-amp fuse between the positive terminal of the power supply and the white wire which leads to the circuit breaker on the power switch assembly. This circuit will protect your boat in the event that the wire which supplies power to the HoseMaster is chaffed or cut.

The circuit breaker that comes installed in the power switch assembly provides protection against the overloading of the HoseMaster motor.

WARRANTY













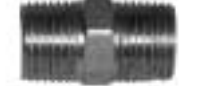

PRODUCT COVERED BY THIS LIMITED WARRANTY: HoseMaster

1. *GLENDINNING MARINE PRODUCTS, INC.* warrants to the original consumer purchaser that the *HoseMaster* will be free from defects in material and workmanship under normal use and service for a period of one (1) year from the date of purchase.
2. *This LIMITED WARRANTY applies to defects in material and workmanship.* It does not apply to plated or painted finishes or to hose damage caused by inadequate hose storage area or installation not in accordance with GLENDINNING MARINE PRODUCTS, INC. specifications.
3. *This LIMITED WARRANTY is void* if the product has been damaged by accident or unreasonable use, neglect, improper installation, or other causes not arising out of defects in material or workmanship.
4. *To obtain performance of this LIMITED WARRANTY* obligation the original purchaser should contact GLENDINNING MARINE PRODUCTS, INC. for instructions concerning removal and shipping of the defective component. Upon compliance of the foregoing procedure all warranted defects will be repaired, or at GLENDINNING MARINE PRODUCTS, INC. option, the complete unit replaced and returned to the consumer, shipping charges prepaid.
5. *GLENDINNING MARINE PRODUCTS, INC.* does not assume the costs of removal and/or installation of the product or any other incidental costs which may arise as a result of any defect in materials or workmanship.

THIS WARRANTY IS IN LIEU OF ALL OTHER EXPRESS WARRANTIES. ANY WARRANTY IMPLIED BY LAW INCLUDING WARRANTIES OF MERCHANTABILITY OR FITNESS, IS IN EFFECT ONLY FOR THE DURATION OF THE EXPRESS WARRANTIES SET FORTH IN THE FIRST PARAGRAPH ABOVE. NO REPRESENTATIVE OR PERSON IS AUTHORIZED TO GIVE ANY OTHER WARRANTY OR TO ASSUME FOR GLENDINNING MARINE PRODUCTS, INC. ANY OTHER LIABILITY IN CONNECTION WITH THE SALE OF IT'S PRODUCTS. GLENDINNING MARINE PRODUCTS, INC. WILL NOT BE LIABLE FOR ANY CONSEQUENTIAL DAMAGES RESULTING FROM THE USE OR INSTALLATION OF IT'S PRODUCTS.



HOSEMASTER ACCESSORIES

PART NUMBER	DESCRIPTION	
51564	WATER PRESSURE REGULATOR — <i>some docks have extremely high pressure at the water source. Protect both your water supply hose and plumbing system by installing this regulator between the HoseMaster and the campsite water source.</i>	
51563	1/2" NPT ELBOW — <i>this accessory is used when space constraints dictate a bend at the hose reel hookup (when mounting adjacent to the storage bay wall).</i>	 <p style="text-align: right;">SIDE VIEW</p> <p style="text-align: left;">FRONT VIEW</p>
51565	1/2" MPT X 1/2" MPT UNION — <i>this accessory is used to attach two female connectors in the plumbing system.</i>	
51574	1/2" MPT X 5/8" BARBED ADAPTER — <i>this accessory is used to attach 5/8" hose to a 1/2" nptf in the plumbing system.</i>	
51573	GHTM - 1/2" BARBED ADAPTER — <i>this accessory is used to attach 5/8" hose to a 1/2" nptf in the plumbing system.</i>	
51566	1/2" MPT X 1/2" MPT CHECK VALVE — <i>this accessory is used in the water supply system to prevent backflow.</i>	
51567	GHTF X 1/2" FPT CHECK VALVE W/CAP & LANYARD — <i>same as above.</i>	
51568	1/2" FPT X 1/2" FPT COUPLER — <i>this accessory is used to attach two male connectors.</i>	
51569	1/2" FPT X GHTM ADAPTER— <i>this fitting is used to adapt male pipe thread to garden hose female thread.</i>	
05516	MOUNTING HARDWARE — <i>this package contains a variety of screws and washers used to mount the hose reel to your coach.</i>	
75551	HOSE CLAMP — <i>this accessory is used to adapt flexible hose to a barbed fitting.</i>	
85558	HOSE CAP WITH LANYARD — <i>this accessory is used to keep contaminants out of the drinking water safe 1/2" IAMPO water hose.</i>	
87550	WASHERS — <i>6 pack of drinking water safe, garden hose washers.</i>	
0551x	INSTALLATION KIT — <i>this kit contains:</i> — <i>mounting hardware, 5' hose (1/2" npt to GHTM),</i> — <i>5' 14-gage wire with butt connectors, and a 90 degree elbow</i>	

J HOSEMASTER PRODUCT REGISTRATION

Please take a moment to validate your product warranty by mailing in this card with the proper information.

FOLLOW THESE SIMPLE STEPS :

STEP 1: Fill in the registration card.

STEP 2: Cut along dotted line.

STEP 3: Affix correct postage.

STEP 4: Drop in mailbox.

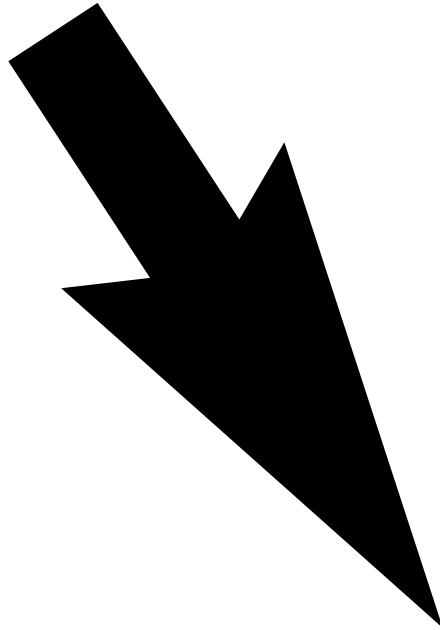

***OR SEND VIA FAX TO:
(843) 399-5005***



HOSEMASTER WARRANTY REGISTRATION			
NAME _____			
ADDRESS _____			
CITY _____		STATE _____	ZIP _____
COUNTRY _____	PHONE _____	EMAIL _____	
BOAT MODEL & YEAR OF MANUFACTURE _____		WOULD YOU LIKE TO RECEIVE INFO ON NEW PRODUCTS FROM GLENDINNING?	
HOSEMASTER SERIAL NUMER _____		YES <input type="checkbox"/>	NO <input type="checkbox"/>
WHAT WOULD YOU LIKE TO SEE IMPROVED / CHANGED? _____			THANK YOU!

PRODUCT WARRANTY INFORMATION

PLACE
STAMP
HERE



**740 CENTURY CIRCLE
CONWAY, SC 29526-8274
USA**